

# 1000 GALLON REGULAR

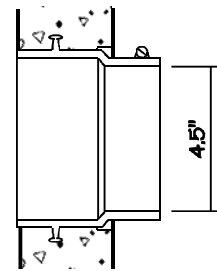

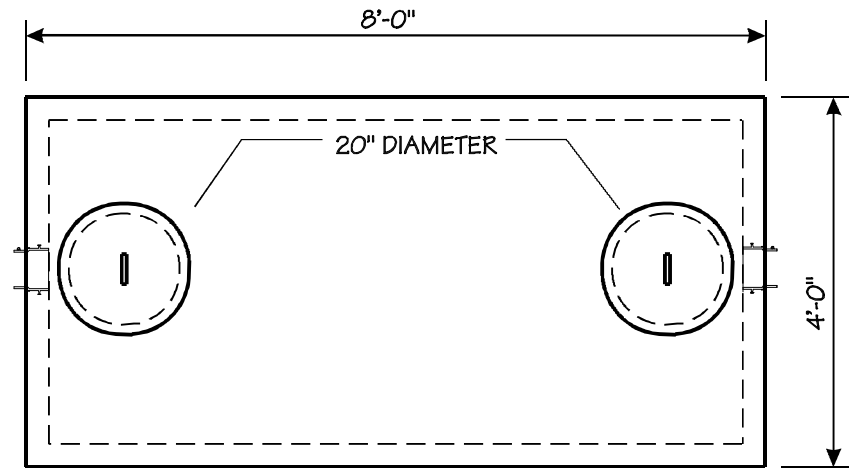

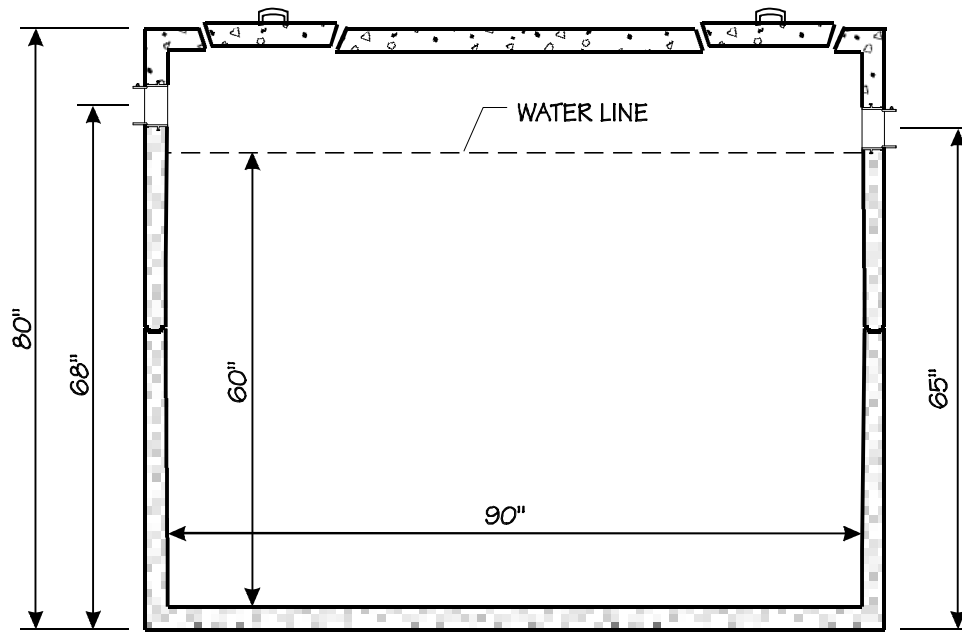
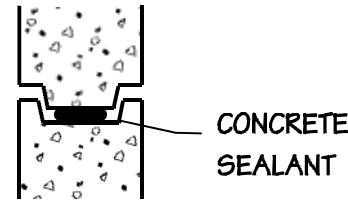

RUBBER BOOT  
DETAIL



JOINT DETAIL

PROJECT			
CUSTOMER			
DRAWN BY		DATE	
COST			
APPROVED BY			
DATE			

VOLUME - CAPACITY:	FABRICATION SPECS:
CAPACITY: 90" x 42" x 60" = 981 GAL.	TONGUE AND GROOVE JOINT, SEALED WITH 1" x 1" BUTYL SEALANT
GALLONS PER INCH = 16.36	REINFORCEMENT - FORTA FERRO STRUCTURAL FIBER
	STRUCTURAL FIBER REINFORCED CONCRETE - 5000 PSI
OVERALL WEIGHT : 6880 LBS.	   



4944 Mason Road, Howell, MI 48843  
 PH 517 546-2810 FAX 517 546-4480  
[www.americanconprod.com](http://www.americanconprod.com)